

E-SERIES

VOLTAGE DIMMABLE CLASS 2 LED DRIVER



The F-M2440 dimmable voltage LED driver is class 2 rated and designed to operate with any standard MLV/Incandescent TRIAC (Leading edge) dimmer switch. Encased in a low profile aluminum enclosure that includes 2 knock-outs to enable easy installation makes it the perfect choice for under cabinet lights, tape lights and various LED fixtures installations. Our electrical specification includes Auto Reset, over current and short circuit protection. Efficiency of 90% and higher allows the driver to operate at low temperatures.

Quick Specs

Input Voltage	Max Output Power	Output Voltage	Max Output Current	Efficiency @ Max Load	THD @ Max. Load	Power Factor @ Max. Load	Envir. Protection Rating	Weight
120VAC	40W	24VDC	1.75A	> 90%	< 20%	> 0.95	NEMA 3R	9oz / 255grams

Wiring Diagram

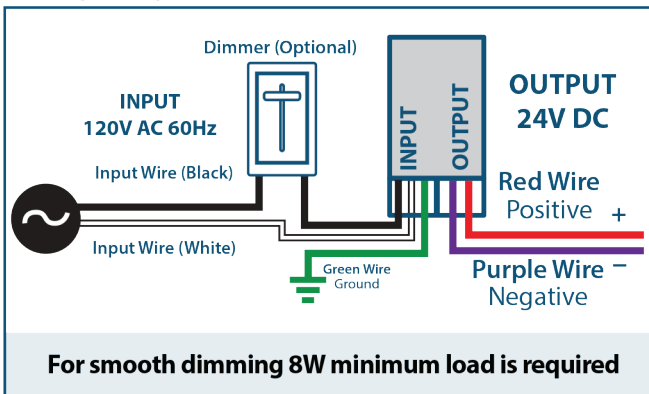

Features

- Dimmable with any standard MLV/Incandescent TRIAC- (Leading edge) dimmer switch
- Dim down to 1%
- Super compact ALUMINUM CASE.
- Class 2
- UL 8750
- Nema 3R - Outdoor Use
- Auto-Reset Protection for short circuits & over-voltage.
- FCC 15 part 2

Enclosure Details IN(MM)

Length	6.77 (171.9)
Width	2.67 (67.8)
Height	1.30 (33)

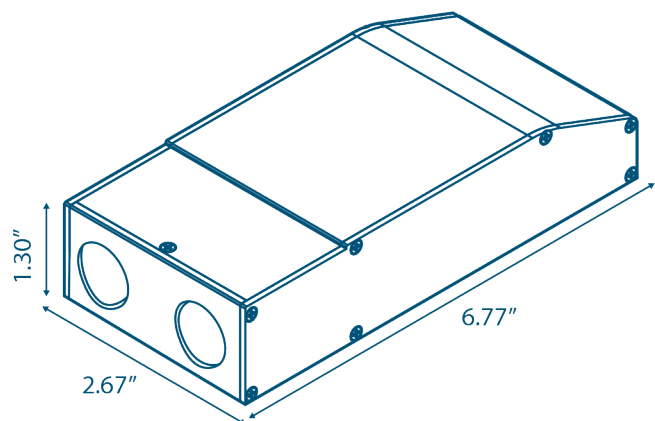

DIM DOWN TO 1%
CLASS 2

Input	
Input Voltage	120VAC
Input Current @ Max Load	0.41 A
Power Factor	0.95
Efficiency	> 90%
Output	
Max Load	40W
Output Voltage	24VDC
Output Current @ Max Load	1.75 A
Environmental	
Operating Ambient Temperature	-30oc - 50oc (-22F - 122F)
Dimming	
Minimum Dimming Level	1%
Protections	
Short Circuit Protection	Yes
Overcurrent Protection	Yes
Over Temperature	Yes
Open Circuit Protections	Yes
Mechanical & Housing	
Input Wires (White \ Black)	18 AWG
Output Wires (Red \ Black)	14 AWG
Length	6.77" (171.9mm)
Width	2.67" (67.8mm)
Height	1.30" (33mm)
Weight	17oz (481grams)
Housing Material	Aluminium
Housing Color	Black
Junction Box	Yes
Mounting	Two Hole flange mounting
Approval Markings	
Certificates / Approval Signs	UL 8750, class 2

Mechanical Diagram

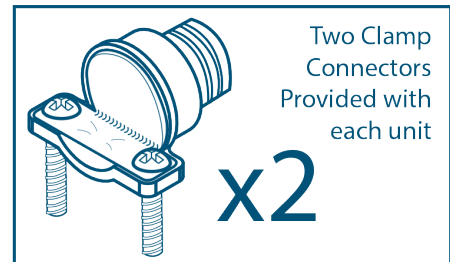
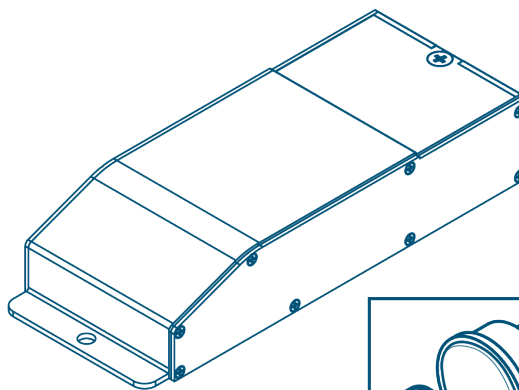
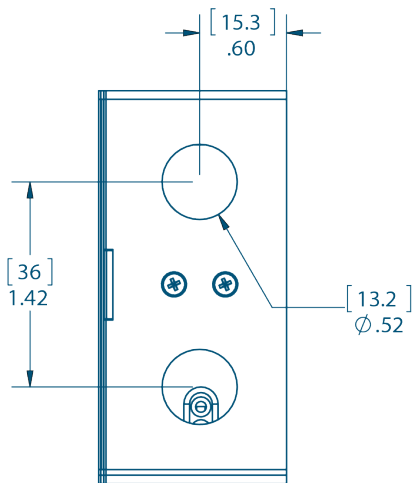
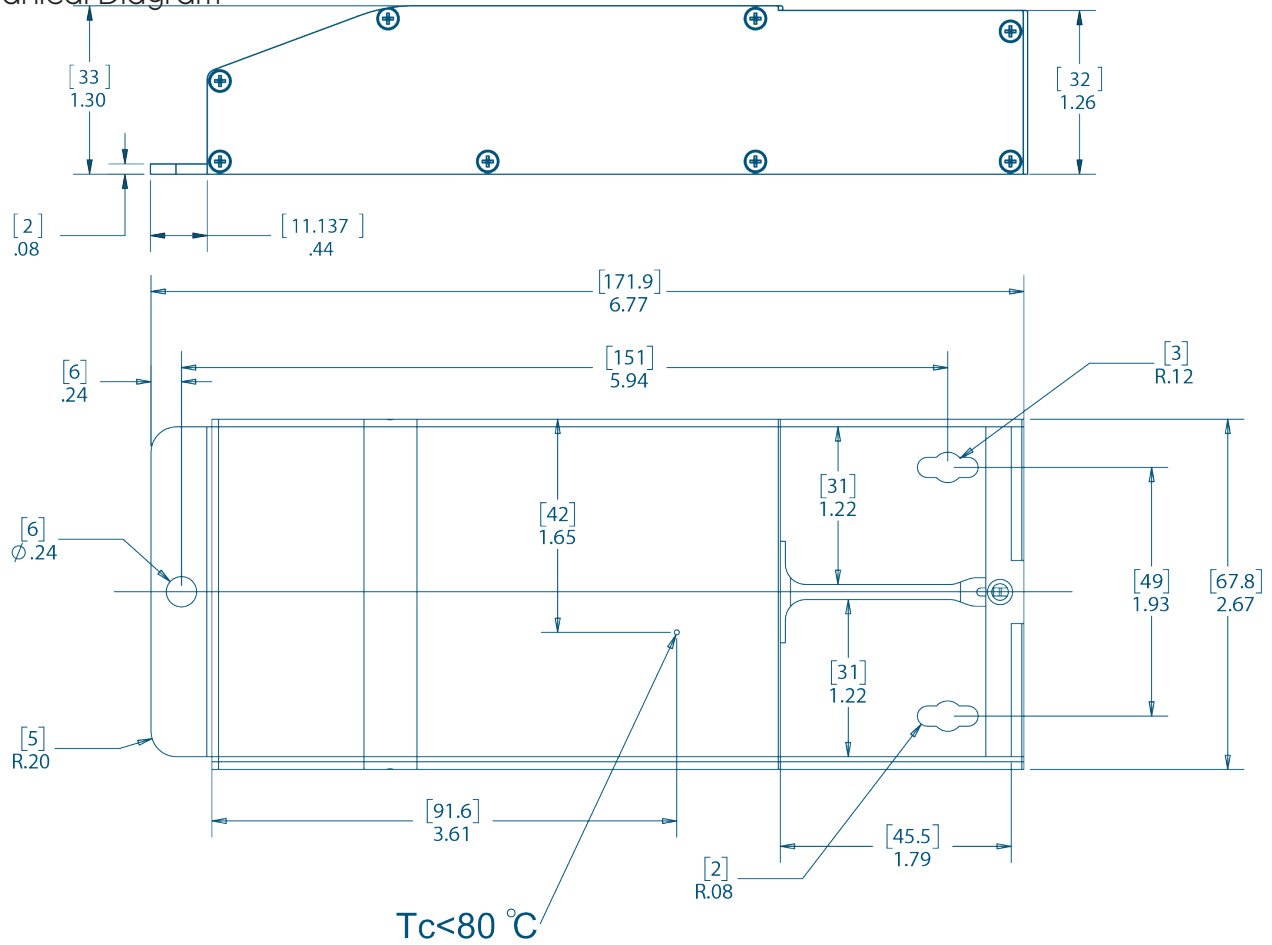

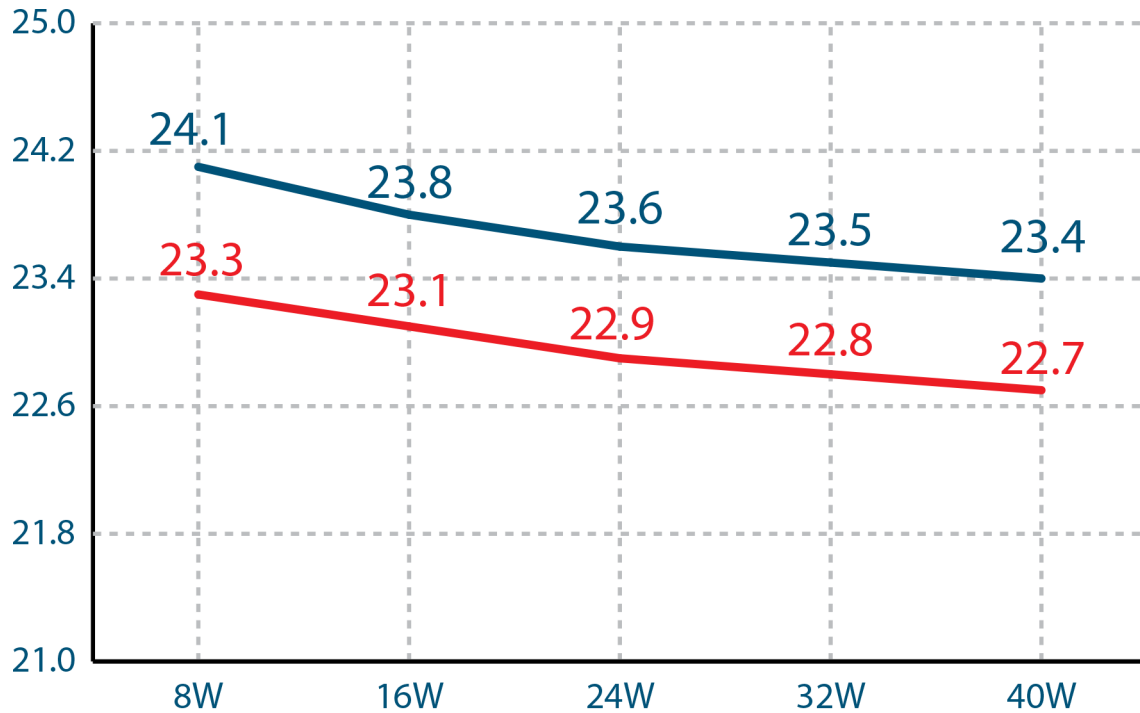

— Output Voltage vs. Load
— Output Voltage With a Typical TRIAC Dimmer (on Max)